



# Ningbo ETDZ Drainage Systems



Innovative

**Make a drain, make a solution**



# Ningbo ETDZ Drainage Systems



Ningbo ETDZ drainage system was created by Ningbo ETDZ Holding LTD. which locate in Haishu district of Ningbo, the company is an expert designer and manufacturer of drainage products for kitchen, bath, balcony and outdoor areas of construction with a wide range of styles and sizes, the highest quality and technically superior design make Ningbo ETDZ drains are durable, easy to maintain and clean, As a supplier with solid experience that not just only supply the customers the products but also many constructive suggestions and innovative drainage solutions.

With a flexible manufacture system to meet the requirement of different clients, custom drains can be made for any size situation and also can customize multiple drain outlets for the high flow capacity. Truly know the reputation is only as good as the products' performance, so we do our best to ensure that the products you buy is the right product and that it is installed correctly in order to do its job successfully.

Contact our friendly sales team with your requirements, you will get a quick response.

## OEM & ODM service

We are excited to bring you a new place to find innovative solutions, when the standard size drains are not meet your actual usage, please kindly tell us all your problems, we dedicate to solve it and supply you the most suitable drainage products for you.

We are honor and welcome to produce the customer designed products with a high quality and quick delivery.



# Stainless steel cover pattern designs



C01



C02



C03



C04



C05



C06



C07



C08



C09



C10



C11



C12

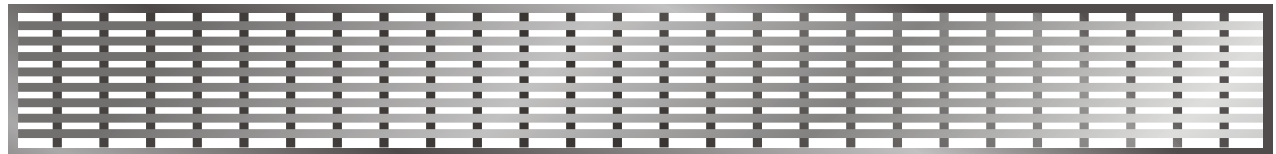

C13

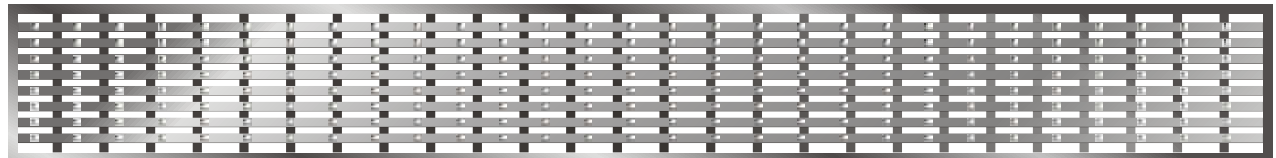

C14



C15



C16



C17

Smooth



C18

Tile insert



C19

Glass black

## Options of outlet



## Water seal traps

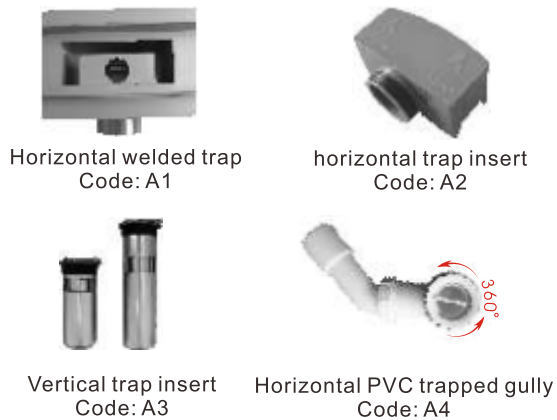

## Choice of accessories

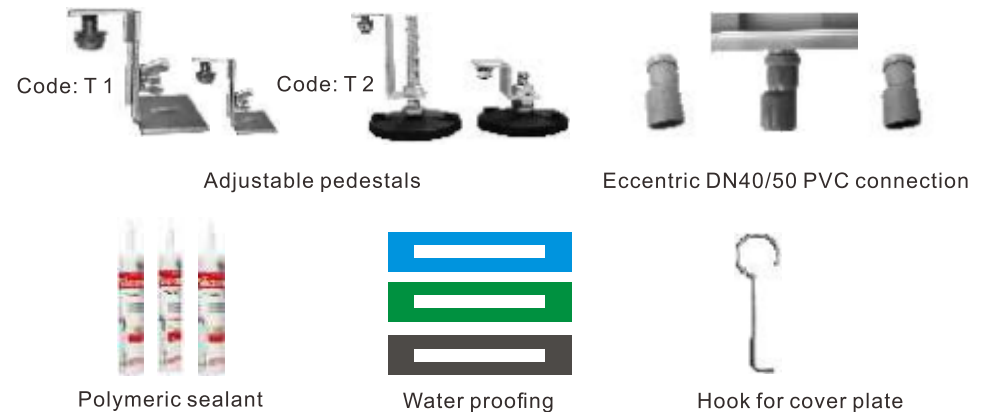

# NO FLANGE SERIES

- \* Made of true stainless steel(SUS304/EN1.4301)
- \* A shiny defect free surface finish, minimise cleaning and maintenance
- \* Compact, streamlined appearance, give you a cheerful new look
- \* Options of dozen of cover grating styles
- \* Bottom of drain body with a "V" design to facilitate flow of water
- \* Flow capability meet European standard En1253
- \* Compatible range of indoor drainage with a coordinated design
- \* Easy for installation



NO FLANGE SERIES

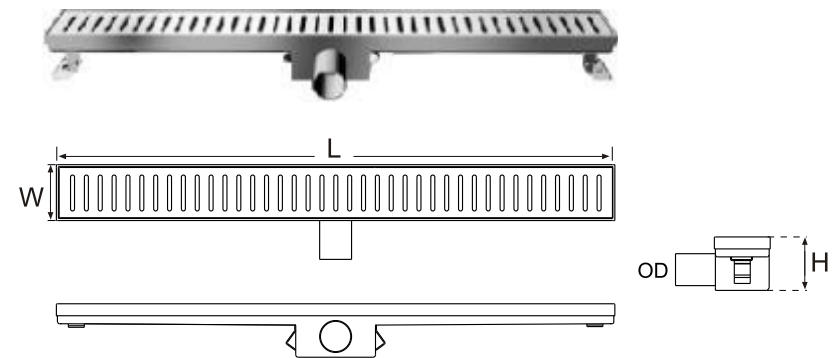

NLH40-A2

## Linear drain without flange

- Connection: Sides out with DN38--DN50(Standard DN40, DN50)  
The minimum height is only 67mm, width 70--100mm, length 300--1200mm  
Choice of water seal traps A1, A2
- With: Options of cover plate, Convenient to unclog  
Height adjustable stand for levelling the cover plate  
Trap insert with deodorant function design  
Customized available

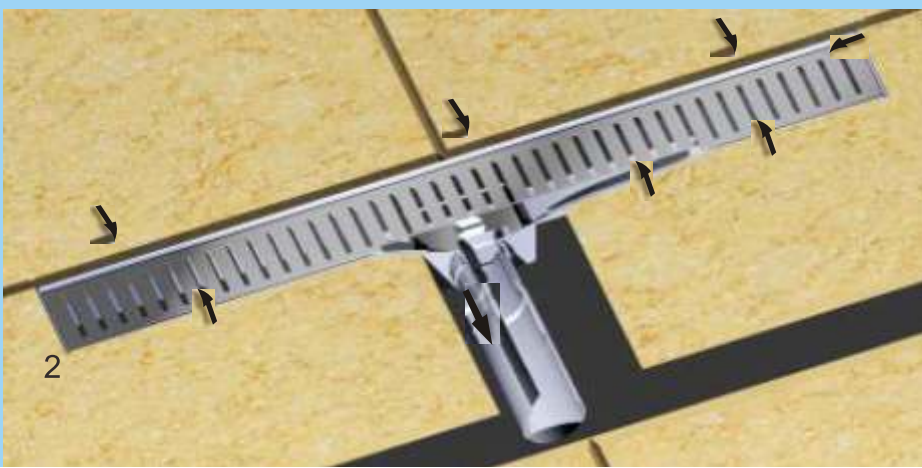

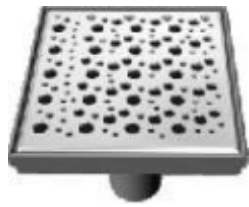

NSV40-A3

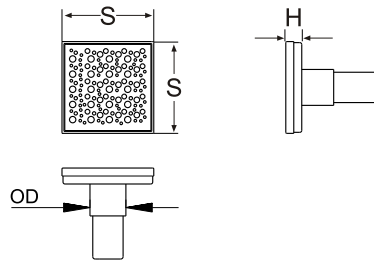

NTH40-A2

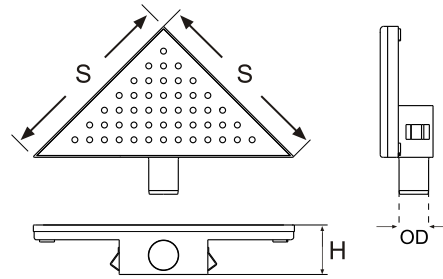

square drain without flange



NRH40-A2

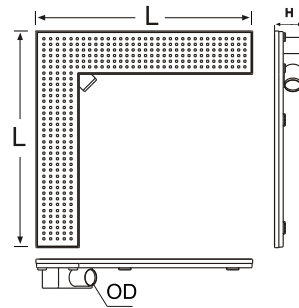

## Square drain without flange

Connection: Vertical outlet with DN38-DN50(Standard DN40, DN50)

Choice of removable trap insert A3

The minimum height is only 20mm if no trap request

with: Choice of height adjustable stand for levelling the cover plate

Options of cover plate, convenient to unclog

Trap insert with deodorant function design

Customized available

## Triangular drain without flange

Connection: Vertical outlet with DN38--DN50(Standard DN40, DN50)

Choice of removable trap insert A1, A2

The minimum height is only 67mm, side of 150-500mm

With: Choice of height adjustable stand for levelling the cover plate

Options of cover plate, convenient to unclog

Trap insert with deodorant function design

Customized available

## "L"shape drain without flange

Connection: Horizontal outlet with DN38--DN50 (standard DN40, DN50)

Choice of removable trap insert A1, A2

The minimum height is only 67mm, width of 70--100mm

Height adjustable stand for levelling the cover plate

with: Options of cover plate. convenient to unclog

Choice of end or centrally located outlet

Trap insert with deodorant function design

Customized available

Item	Length(mm)	Width(mm)	Side(mm)	OD(mm)	Drain direction	Height(mm)	Trap	Adjustable stand	Wal
Linear	300~1200	70~100	×	38~50	Horizontal/Vertical	67~100/20~50	A1,A2,A4/A3	T1,T2	×
Square	×	×	150~500	38~50	Horizontal/Vertical	67~100/20~50	A1,A2,A4/A3	T1,T2	×
"L"Shape	300~1200	70~100	×	38~50	Horizontal/Vertical	67~100/20~50	A1,A2,A4/A3	T1,T2	×
Triangular			150~500	38~50	Horizontal/Vertical	67~100/20~50	A1,A2,A4/A3	T1,T2	×
Customized	√	√	√	38~50	Horizontal/Vertical	67~100/20~50	A1,A2,A4/A3	T1,T2	×

Cover plate(Dozens of pattern styles for choice)

Waterproofing

Water seal trap insert

Drain body

Flange

Length 300mm--1200mm

Adjustable pedestals for levelling the cover plate

Outlet

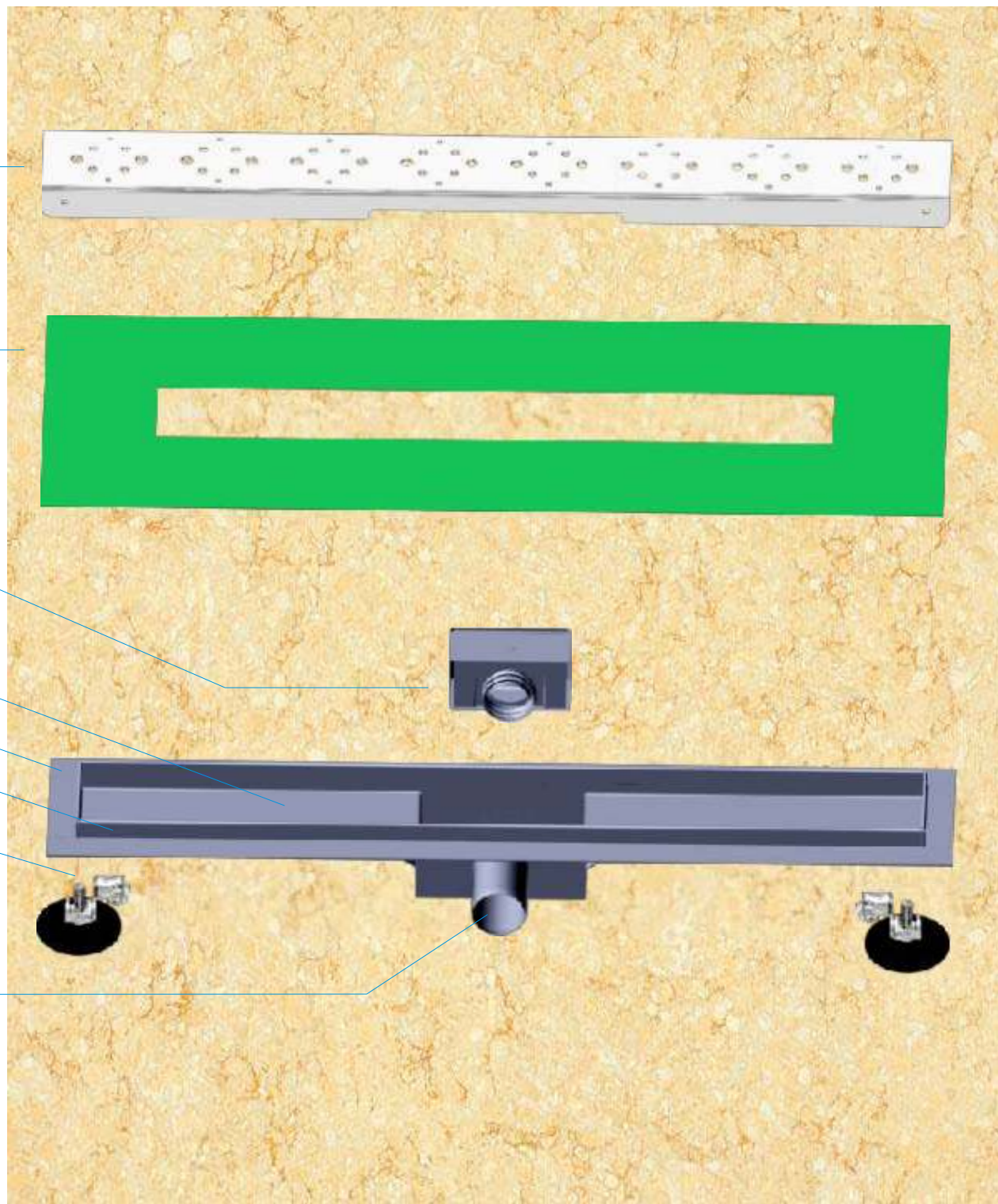



FLH40-A2

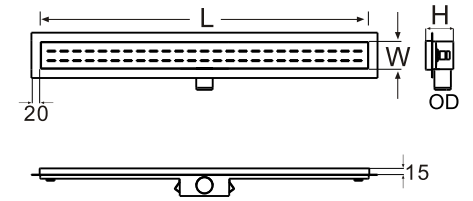

### Linear drain with 20mm flange

Connection: Horizontal outlet with DN38--DN50 (Standard DN40, DN50)

Choice of water seal traps A1, A2

The minimum height is only 67mm, width 70-100mm, length 300-1200mm

with: Options of cover plate, Convenient to unclog

Height adjustable stand for levelling the cover plate

Trap insert with deodorant function design

Available of custom special size



FLH40-A4

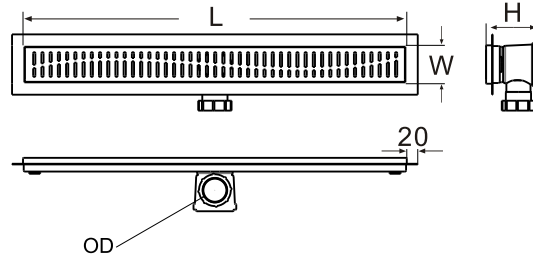

### Linear drain with 20mm flange

Connection: Horizontal outlet with DN50

Removable PVC water seal trap A4, universal outlet with 360° revolve

Height is 100mm, width 70-100mm, length 300-1200mm

with: Options of cover plate, Convenient to unclog

Height adjustable stand for levelling the cover plate

Trap insert with deodorant function design

Available of custom special



FLV40-A3

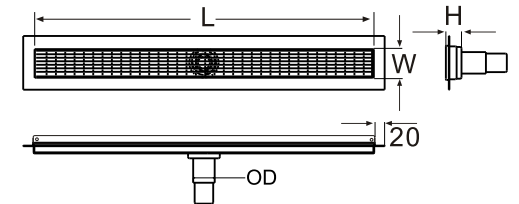

### Linear drain with 20mm flange and wall design

Connection: Vertical outlet with DN38--DN50(Standard DN40, DN50)

Water seal trap insert A3

The minimum height is only 20mm if no trap request, width 70-100mm

Options of cover plate, Convenient to unclog

with: Choice of height adjustable stand for levelling the cover plate

Trap insert with deodorant function design

Choice of end or centrally located outlet

Available of custom special size



FSH40-A2

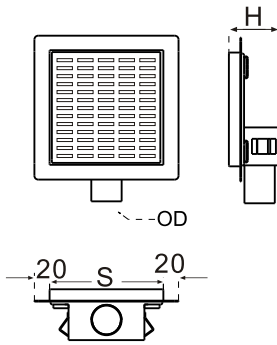

### Square drain with 20mm flange

Connection: Horizontal outlet with DN38--DN50(Standard DN40, DN50)  
 Choice of removable trap insert A1, A2  
 Height 67-100mm, width of 150-500mm  
 with: Height adjustable stand for levelling the cover plate  
 Options of cover plate, convenient to unclog  
 Trap insert with deodorant function design  
 Available of custom special size



FTH40-A2

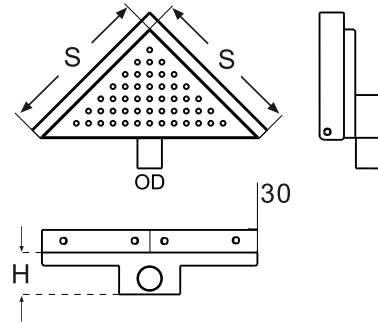

### Triangular drain with 20mm flange and wall design

Connection: Horizontal outlet with DN38—DN50(Standard DN40, DN50)  
 Choice of trap insert A1, A2  
 The minimum height is only 67mm  
 Height adjustable stand for levelling the cover plate  
 with: Options of cover plate, convenient to unclog  
 Wall design along the wall for easier to install  
 Trap insert with deodorant function design, no worry of stench and worm  
 Customized available



FRH40-A2

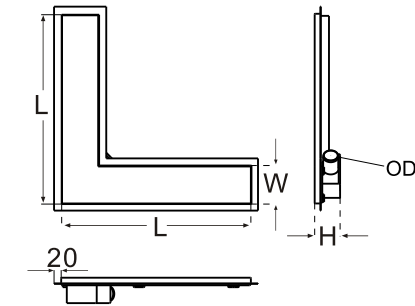

### "L" shape drain with 20mm flange

Connection: Horizontal outlet with DN50  
 Removable PVC trap insert A4  
 Height is 100 mm, customized width 70-100mm  
 Height adjustable stand for levelling the cover plate  
 with: Options of cover plate, convenient to unclog  
 Choice of outlet locate  
 Trap insert with deodorant function design  
 Customized available

Item	Length(mm)	Width(mm)	Side(mm)	OD(mm)	Drain direction	Height(mm)	Trap	Adjustable stand	Wal
Linear	300~1200	70~100	x	38~50	Horizontal/Vertical	67~100/20~50	A1,A2,A4/A3	T1,T2	✓
Square	x	x	150~500	38~50	Horizontal/Vertical	67~100/20~50	A1,A2,A4/A3	T1,T2	✓
"L"Shape	300~1200	70~100	x	38~50	Horizontal/Vertical	67~100/20~50	A1,A2,A4/A3	T1,T2	✓
Triangular			150~500	38~50	Horizontal/Vertical	67~100/20~50	A1,A2,A4/A3	T1,T2	✓
Customized	✓	✓	✓	38~50	Horizontal/Vertical	67~100/20~50	A1,A2,A4/A3	T1,T2	✓



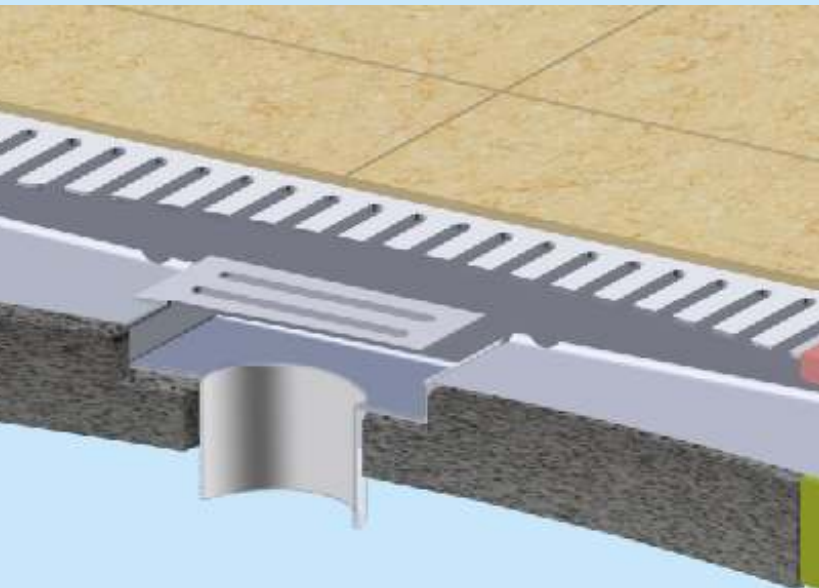

ULV50-A3

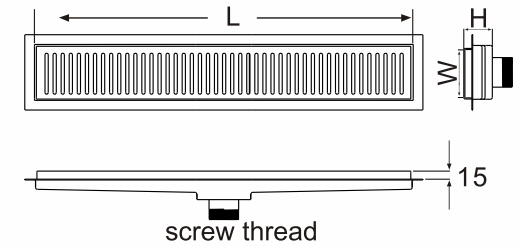

### Linear drain with 20mm flange

Connection: Vertical screw thread outlet with DN38--DN50(Standard DN40, DN50)

Shallow "V" design of drain body for a quick drainage

Screw thread outlet specially develop for Australia markets

Choice of water seal trap insert A3

with: The minimum height is 53mm, width 70-100mm, length 300-1200mm

Options of cover plate, Convenient to unclog

Choice of height adjustable stand for levelling the cover plate

Trap insert with deodorant function design

Choice of end or centrally located outlet

Available of custom special size



ULH40-A2

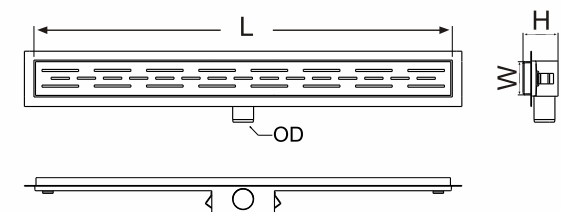

### Linear drain with 20mm flange

Connection:Horizontal outlet with DN38~DN50(Standard DN40, DN50)

Choice of water seal traps A1, A2

The minimum height is only 67mm, width 70~100mm

Options of cover plate, convenient to unclog

With:Height adjustable stand for levelling the cover plate

Trap insert with deodorant function design, no worry of stench and worm

Choice of end or centrally located outlet

Available of special size



UTV40-A3

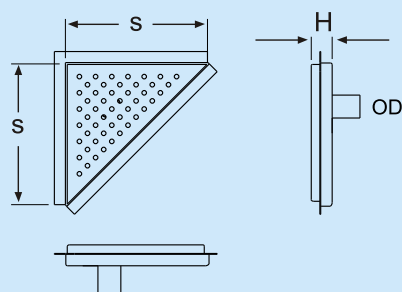

### Triangular drain with 20mm flange

Connection: Vertical outlet with DN38~DN50 (Standard DN40, DN50)

Water seal trap insert A3

The minimum height is 35 mm if no trap request

Choice of height adjustable stand for levelling the cover plate

With: Options of cover plate, convenient to unclog

Trap insert with deodorant function design

Available of custom special size



USV40-A3

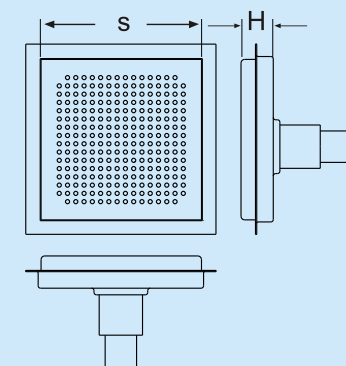

### Square drain with 20mm flange

Connection: Vertical outlet with DN38~DN50 (Standard DN40, DN50)

Removable trap insert A3

Choice of height adjustable stand for levelling the cover plate

With: Options of cover plate, convenient to unclog

Trap insert with deodorant function design,  
no worry of stench and worm

Available of custom special size

Item	Length(mm)	Width(mm)	Side(mm)	OD(mm)	Drain direction	Height(mm)	Trap	Adjustable stand	Wal
Linear	300~1200	70~100	x	38~50	Horizontal/Vertical	67~100/35~50	A1,A2,A4/A3	T1,T2	✓
Square	x	x	150~500	38~50	Horizontal/Vertical	67~100/35~50	A1,A2,A4/A3	T1,T2	✓
"L"Shape	300~1200	70~100	x	38~50	Horizontal/Vertical	67~100/35~50	A1,A2,A4/A3	T1,T2	✓
Triangular			150~500	38~50	Horizontal/Vertical	67~100/35~50	A1,A2,A4/A3	T1,T2	✓
Customized	✓	✓	✓	38~50	Horizontal/Vertical	67~100/35~50	A1,A2,A4/A3	T1,T2	✓



## Perimeter frame design series

- \* Made of true stainless(SUS304/EN1.4301)
- \* A 15mm perimeter angle frame is available to reduce the risk of tile breakages alongside the channel edge.
- \* Streamlined shiny metal appearance, give you an eclectic new look
- \* Sanded flange design to secure bonding of under tile waterproofing
- \* A shiny defect free surface finish,minimise cleaning and maintenance
- \* Options of dozen of cover grating style
- \* Bottom of drain body with a “V” design to facilitate flow of water
- \* Compatible range of indoor drainage with a coordinated design

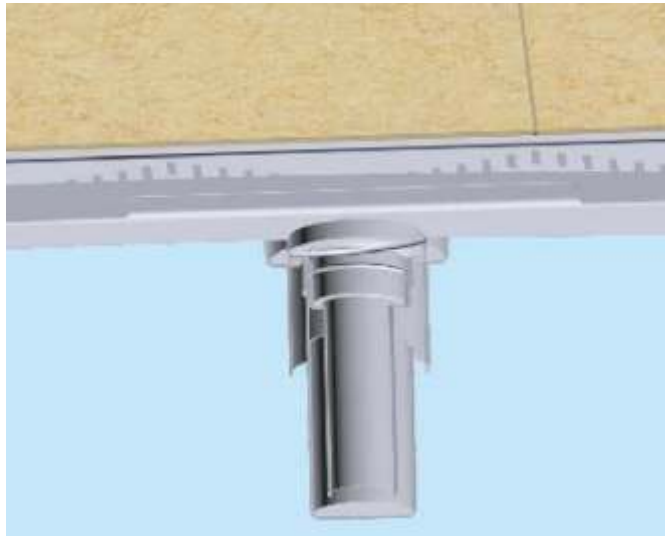

PLH40-A4

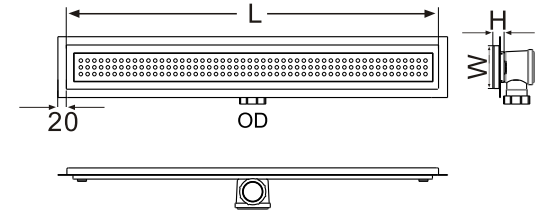

### Linear drain with 20mm flange

Connection: Horizontal outlet with DN50

Removable PVC water seal trap A4, universal outlet with 360° revolve

Height is 100mm, width 70~100mm, length 300~1200mm

With: Options of cover plate, Convenient to unclog

Height adjustable stand for levelling the cover plate

Trap insert with deodorant function design, no worry of stench and worm

Available of custom special size



PLV40-A3

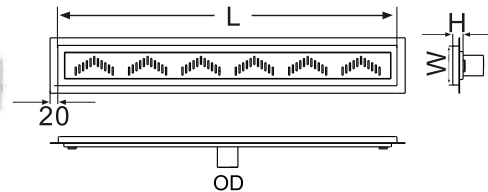

### Linear drain with 20mm flange

Connection: Vertical outlet with DN38~DN50 (Standard DN40, DN50)

Water seal trap insert A3

The minimum height is only 20mm if no trap request, width 70~100mm

Options of cover plate, Convenient to unclog

With: Choice of height adjustable stand for levelling the cover plate

Trap insert with deodorant function design

Choice of end or centrally located outlet



PLH40-A32

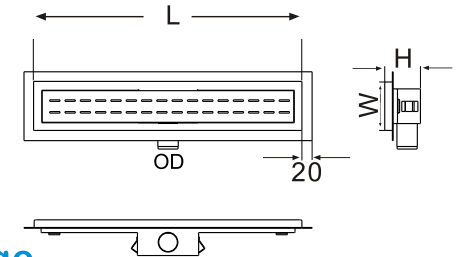

### Linear drain with 20mm flange

Connection: Horizontal outlet with DN38~DN50 (Standard DN40, DN50)

Choice of water seal traps A1, A2

The minimum height is only 67mm, width 70~100mm, length 300~1200mm

Options of cover plate, Convenient to unclog

With: Height adjustable stand for levelling the cover plate

Trap insert with deodorant function design

Available of custom special size

Item	Length(mm)	Width(mm)	Side(mm)	OD(mm)	Drain direction	Height(mm)	Trap	Adjustable stand	Wal
Linear	300~1200	70~100	x	38~50	Horizontal/Vertical	67~100/20~50	A1,A2,A4/A3	T1,T2	✓
Square	x	x	150~500	38~50	Horizontal/Vertical	67~100/20~50	A1,A2,A4/A3	T1,T2	✓
"L"Shape	300~1200	70~100	x	38~50	Horizontal/Vertical	67~100/20~50	A1,A2,A4/A3	T1,T2	✓
Triangular			150~500	38~50	Horizontal/Vertical	67~100/20~50	A1,A2,A4/A3	T1,T2	✓
Customized	✓	✓	✓	38~50	Horizontal/Vertical	67~100/20~50	A1,A2,A4/A3	T1,T2	✓

# Trench drain system

The trench drain system is designed for a variety of applications, both indoor and outdoors, commercial, industrial and hospital. Drain is more stronger than ordinary cement concrete, which can be installed using existing construction techniques, are simple, economic, and heavy duty. The drain channels are easy to install, durable, resistant to many chemicals and solution for freeze, thaw applications, the flow rates equal to or greater than most larger poured-in-place trench drain grates.

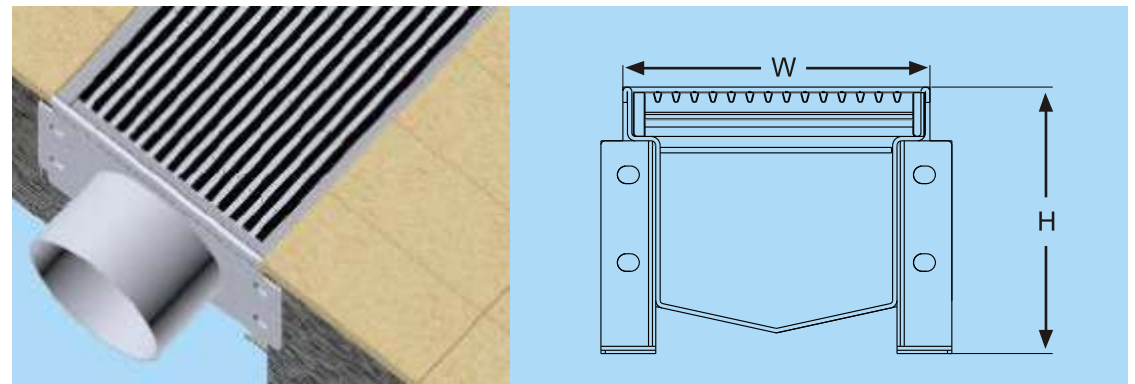

- \* Consist of grate cover, channel, flange connection and fittings.
- \* Made of true stainless SUS304 or SUS316
- \* Choice of grate covers, welded wedge wire grate or punched hole grate
- \* Channel standard size with length 500~6000mm, height 110mm, width 140mm, thickness 1.2~1.5mm, wedge wire grating height 20mm
- \* A high weight capacity with a high passing ability and warping preventing
- \* Non-slip design, bumps or EPDM mat
- \* High flow capability, meet European standard En 1253
- \* Compatible rang of indoor and outdoor drainage areas
- \* Custom special size welcomed



## Slotted channel

Slotted channels are suited for large areas with low volumes of waste water such as in dining room, meat processors, dishwashing and cooking areas of a kitchen, etc. Neat and unobtrusive, a good choice as a barrier between designated wet and dry zones.

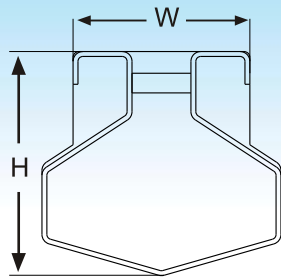

- \* Made of true stainless SUS304 or SUS316
- \* Perimeter angle frame is available to reduce the risk of tile breakages along side the channel edge.
- \* Available in customized sizes, length 1000mm~6000mm, height 65~180mm with or without against wall design, material thickness 1.5mm
- \* Easy to clean, the water along the channel bottom to outlet
- \* Suit for tiled floor
- \* Choice of channel grate locate in the middle of channel
- \* A high weight capacity with a high passing ability and warping preventing
- \* Customized size welcomed

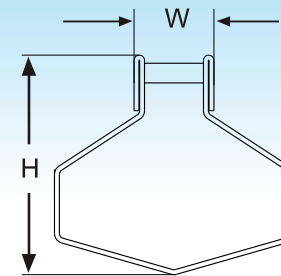

- \* Made of true stainless SUS304 or SUS316
- \* Solid stainless steel bar to prevent channel deformation or movement in load bearing areas.
- \* With a standard length 1000mm~6000mm, height 65~180mm with or without against wall design, thickness 1.5mm
- \* Easy to clean, the water along the channel bottom to outlet
- \* Suit for tiled floor
- \* Choice of channel grate locate in the middle of channel
- \* A high passing ability and warping preventing
- \* Customized size welcomed

# Typical channel

This type of channel for use with wedge wire grating or punched cover can be used in a range of areas, such as balcony, roof, courtyard, drive way, pool areas and so on.

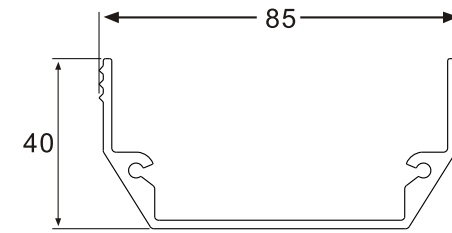

- \* Channel body made of special Aluminum
- \* Reinforcing in the channel middle
- \* With standard width 85mm, height 40mm, material thickness of 2mm
- \* Option of covers, wedge wire grating or punched grate
- \* A high flow capability
- \* Easy to clean, the water along the channel bottom to outlet
- \* A high passing ability and warping preventing
- \* Custom product welcomed

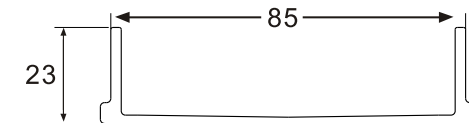

- \* Channel body made of special Aluminum
- \* With standard width 85mm, height 23mm, material thickness of 2.5mm
- \* Option of covers, wedge wire grating or punched grate (see page 3)
- \* Streamlined appearance, unique, a cheerful new look
- \* Suit for tiled floor such as balcony, courtyard, pool side, walk way
- \* Easy to install and clean, the water along the channel bottom to outlet
- \* A high weight capacity with a high passing ability and warping preventing
- \* Custom product welcomed

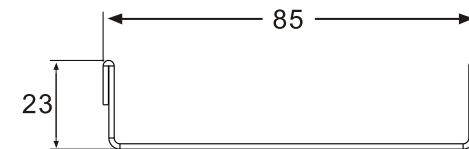

- \* Channel body made of stainless steel SUS304
- \* Standard width 85mm, height 23mm, material thickness of 1.2mm
- \* Option of covers, wedge wire grating or punched grate
- \* Streamlined appearance, unique, a cheerful new look
- \* Suit for tiled floor such as balcony, courtyard, pool side, walk way
- \* Easy to install and clean, the water along the channel bottom to outlet
- \* A high weight capacity with a high passing ability and warping preventing
- \* Custom product welcomed

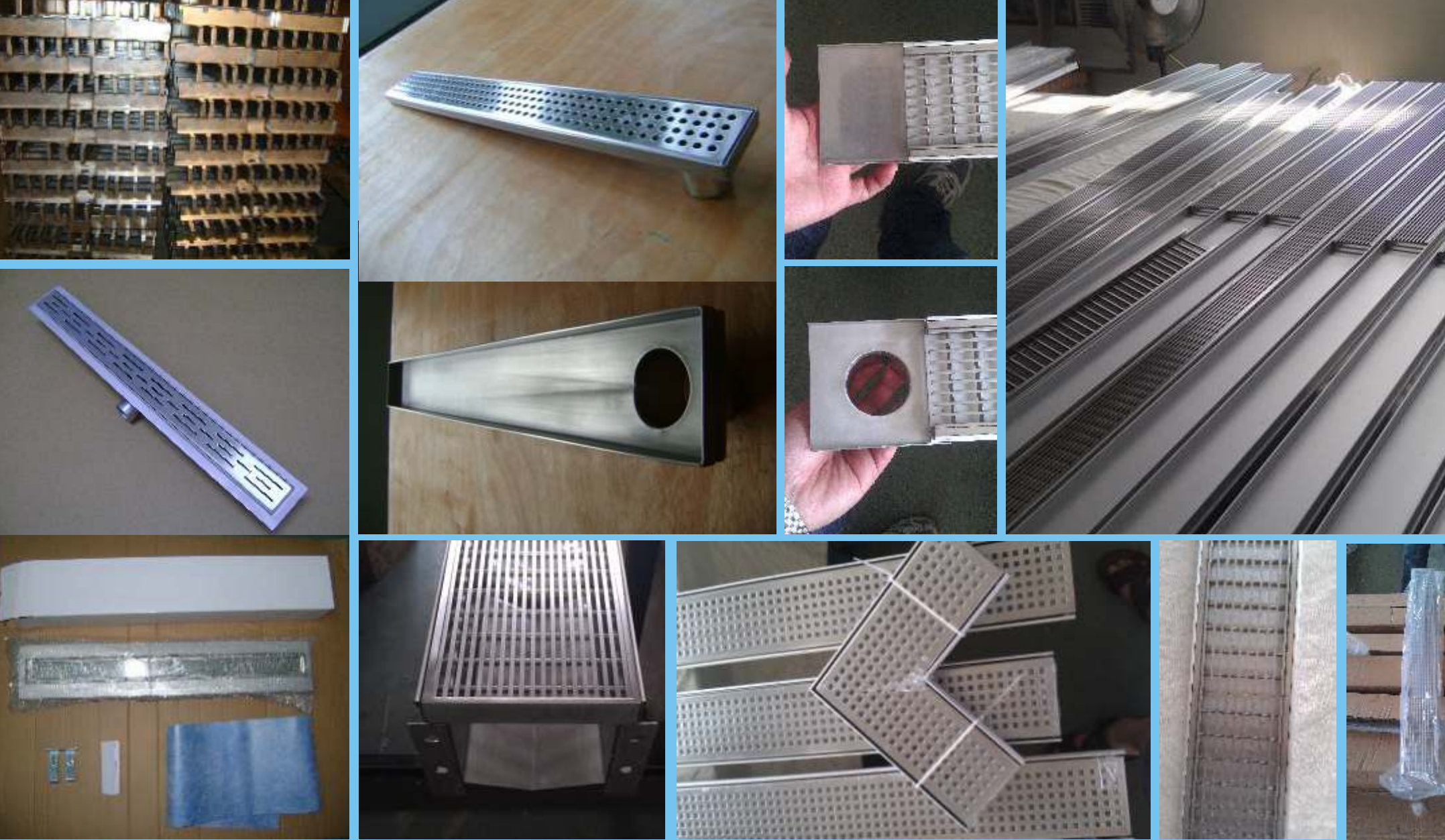

Ningbo ETDZ Drainage Systems

**NINGBO ETDZ HOLDINGS LTD.**

Address: 7-10/F., Galaxy Tower, 35 Changchun Road, Ningbo, China

Tel: **+86 574 87622713**

Email: [cunwei\\_xu@vip.163.com](mailto:cunwei_xu@vip.163.com)

Website: <http://www.nbetdz.com>